

Time delay relays

FUJI time delay relays feature top performance and dependability. These compact industrial time delay relays are specifically designed for process control, machine tools, safety device control, and other applications in which space is at a premium and reliability essential.

FUJI manufactures a wide variety of highly versatile time delay relays, which include Super Timers and digital timers that meet diverse needs in industry.

03



KKD05-126

■ Super Timers

● MS4S/Multimode and compact body

The MS4S is a timer with four operation modes. The on-delay, flicker, one-shot or signal off-delay operation modes can be selected.

See page 03/52 for further information.



KKD05-145

● ST7P/Miniature size

The ST7P is a highly efficient miniaturized on-delay timer.

The maximum timing interval is 12 hours.

See page 03/60 for further information.

Time Delay Relays

Ordering code system

■ Ordering code system

● Super Timer MS4S series

M S 4 S M-AP 1T

① ② ③ ④ ⑤⑥ ⑦⑧

① Product category

Code	Description
M	Timer, counter

② Series category

Code	Description
S	Super timer

③ Timer size

Code	Description
4S	DIN 48mm square

④ Version

Code	Operation
M	Multimode operation
A	On-delay operation
C	On-delay operation with instantaneous contact
F	Off-delay operation
Y	For star-delta starting
R	Repeat operation

⑤⑥ Input voltage

Code	Input voltage
A P	100-240V AC
C E	24V AC/DC
D L	48-127V DC

⑦⑧ Timing range

Code	Timing range
1 T	0.6 - 12s (MS4SF)
1 N	0.6 - 12min (MS4SF)

● Super Timer ST7P series

M S 7 P 2-AP 1T

① ② ③ ④ ⑤ ⑥⑦ ⑧⑨

① Product category

Code	Description
M	Timer, counter

② Series category

Code	Description
S	Super timer

③ Timer size

Code	Description
7	Miniature type

④ Mounting

Code	Mounting
P	Plug-in
B	Printed circuit board

⑤ Output contact

Code	Contact arrangement
2	Timed, 2PDT
4	Timed, 4PDT
Blank	Timed, SPDT (ST7PF only)

⑥⑦ Input voltage

Code	Input voltage
A 2	200-230V AC
A 1	100-120V AC
A P	240V AC
A E	24V AC
D 1	100-110V DC
D F	48V DC
D E	24V DC
D B	12V DC

⑧⑨ Timing range

Code	Timing range
P 5	0.06 - 0.5s(MS7P□,7B□)
1 S	0.1 - 1s(MS7P□,7B□)
3 S	0.3 - 3s(MS7P□,7B□)
5 S	0.4 - 5s(MS7P□,7B□)
1 T	1 - 10s(MS7P□,7B□)
3 T	2 - 30s(MS7P□,7B□)
6 T	4 - 60s(MS7P□,7B□)
3 M	0.25 - 3min(MS7P□,7B□)
1 N	1 - 10min(MS7P□,7B□)
3 N	2 - 30min(MS7P□,7B□)
6 N	4 - 60min(MS7P□,7B□)
2 H	0.2 - 2h(MS7P□,7B□)
6 H	0.5 - 6h(MS7P□,7B□)
1 J	1 - 12h(MS7P□,7B□)
2 J	2 - 24h(MS7P□,7B□)

● Socket (For MS4S)

Mounting	Terminal	Type	Ordering code
Surface	Screw	TP411X	MX41X2
Surface	Screw	TP48X	MX48X2
Flush	Screw	TP411SBA	MX41N1A
Flush	Screw	TP48SB	MX48N1
Flush	Soldering	ATX1NS	MX48NS
Flush	Soldering	ATX2NS	MX41NS

● Socket (For ST7P)

Mounting	Terminal	Type	Ordering code
Surface	Soldering	TP88	MX58
Surface	Soldering	TP814	MX54
Surface	Wire wrap	TP88R2	MX58R2
Surface	Wire wrap	TP814R2	MX54R2
Surface	P. C. board	TP88B	MX58B
Surface	P. C. board	TP814B	MX54B
Surface	Screw	TP88X2	MX58X2
Surface	Screw	TP814X2	MX54X2
Surface	Screw	TP88X1	MX58X1
Surface	Screw	TP814X1	MX54X1

● Accessory

Description	Type	Ordering code
Hold-down spring	FX3	MZ24
Adaptor	TX4	MZ34

■ Types

Description	Operation	Contact arrangement		Timer body Type	Required socket type		
		Timed	Instant.		Surface mounting Type	Flush mounting Type	Rail mounting Type
Super Timer Multi-range, compact body	Multi-mode • On-delay • Flicker • One-shot • Signal off-delay	2PDT	–	MS4SM	TP411X 11GB + FX3 (Hold-down spring)	TP411SBA+TX4 (Adaptor) ATX2NS+TX4 (Adaptor)	TP411X
	On-delay	2PDT SPDT	– SPDT	MS4SA MS4SC	TP48X 8GB + FX3 (Hold-down spring)	TP48SB+TX4 (Adaptor) ATX1NS+TX4 (Adaptor)	TP48X
	Off-delay	2PDT SPDT	–	MS4SF MS4SF-R			
	Star-delta	2NO	1NO	MS4SY			
	On-off repetitive operation	2PDT	–	MS4SR			
Super Timer Miniature size	On-delay	2PDT	–	ST7P-2	TP88 TP88R2 TP88B	–	TP88X2 TP88X1
	On-delay	4PDT	–	ST7P-4	TP814 TP814R2 TP814B	–	TP814X2 TP814X1

03

Time Delay Relays

Super Timers

MS4S

Direct-reading time-scale and compact body MS4S Super Timer

MS4S series Super Timers feature an easy setting and direct-reading system of four time-scale. MS4SM timer is multimode operation type and MS4SA and MS4SC timers are on-delay operation type.

■ Features

- Time-scale indication window and time-scale selector
By turning a time-scale selector, the timing-scales appear in the indication windows one set a time. Although this is a multimode timer, the optional times such as 56 or 27 minutes can be easily set with the direct-reading time-scale.
- Compact timer with instantaneous contact
On-delay timers with instantaneous contact, as well as multimode and on-delay timers, are compact. The front to back length of the timers is only 66.5mm.
- Operation mode indication window and operation mode selector
Four operation modes are provided (MS4SM type only). By turning the operation mode selector, the on-delay, flicker, one-shot, or signal off-delay operation mode can be selected. The present mode is shown in the operation mode indication window with the marks PO, FL, OS or SF.

- LED power ON and output indicator
The power-source lamp (Green) is lit when power is on and flickers during timer operation. The output lamp (Red) is lit when the timed NO contact is on.
- Wide range of AC supply voltage
Supply voltages of 100 to 240V AC are commonly available (ordering code: AP type only).
- Instantaneous operation function with 0 indication
When the timer dial is set at 0, output is given instantaneously, allowing sequence checks to be performed easily.
- Time unit indication window and time unit selector
By turning the time selector, time units of 0.1 sec., sec., min, and hours. can be selected and made to appear in the indication window.
- Improvement of resistance to waveform distortion
The resistance to distortion of secondary voltage waveform of the power supply caused by inverters and uninterruptible power supplies (UPS) is improved.

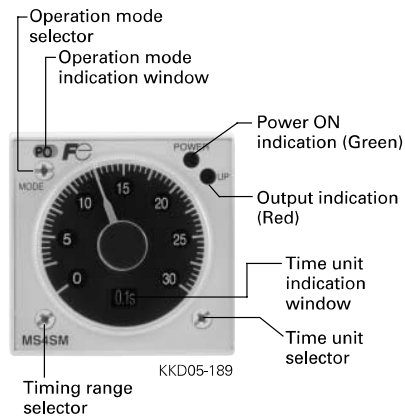

- UL, cULus and TÜV approved

■ Timing range/16 ranges

Time-scale	Time unit indication window			
	0.1s	sec	min	hrs
0 1 2 3 4 5 6	0.05 – 0.6s	0.05 – 6s	0.5 – 6min	0.5 – 6h
0 2 4 6 8 10 12	0.1 – 1.2s	1 – 12s	1 – 12min	1 – 12h
0 5 10 15 20 25 30	0.25 – 3s	2.5 – 30s	2.5 – 30min	2.5 – 30h
0 10 20 30 40 50 60	0.5 – 6s	5 – 60s	5 – 60min	5 – 60h

■ Type number nomenclature

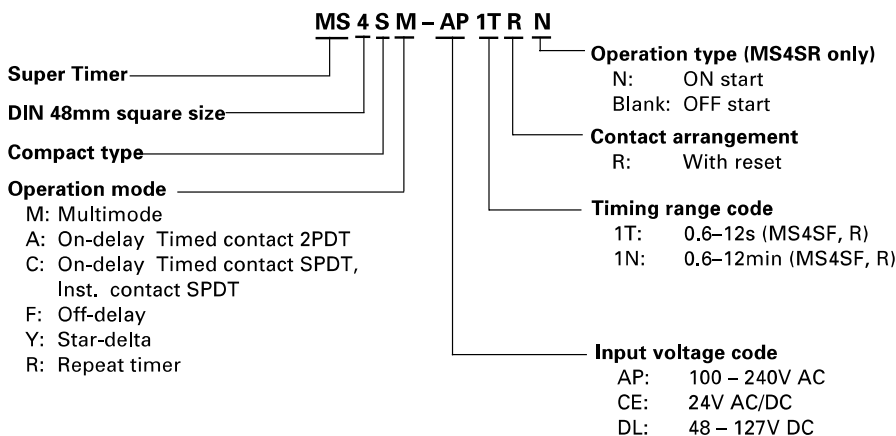

■ Ordering information

Specify the following
1. Ordering code or type number of body and socket.

■ Specifications (MS4SM, MS4SA, MS4SC)

Type	Ordering code	Input voltage	Operation	Contact	Timing range	Socket *
MS4SM	MS4SM-AP	100 – 240V AC 24V AC/DC 48 – 127V DC	On-delay Flicker One-shot Signal off-delay	Timed: 2PDT 5A	Total 16 ranges 0.05 – 0.6s 0.1 – 1.2s 0.25 – 3s 0.05 – 6s 0.5 – 6 (s, min, h) 1 – 12 (s, min, h) 2.5 – 30 (s, min, h) 5 – 60 (s, min, h)	Surface mounting: TP411X 11GB(RX1G)+FX3(MZ24) Flush mounting: TP411SBA ATX2NS(MX41NS)
	MS4SM-CE					
	MS4SM-DL					
MS4SA	MS4SA-AP	100 – 240V AC 24V AC/DC 48 – 127V DC	On-delay	Timed: 2PDT 5A		Surface mounting: TP48X(MX48X2) 8GB(RX8G)+FX3(MZ24)
	MS4SA-CE					
	MS4SA-DL					
MS4SC	MS4SC-AP	100 – 240V AC 24V AC/DC 48 – 127V DC	On-delay	Timed: SPDT Instant: SPDT 5A		Flush mounting: TP48SB(MX48N1) ATX1NS(MX48NS)
	MS4SC-CE					
	MS4SC-DL					

03

* (): Ordering code

■ Technical data (MS4SM, MS4SA, MS4SC)

Repeat accuracy	±0.3% at max. setting time
Reset time	0.1s or less
Operating voltage range	0.85 to 1.1 times rated input voltage
Operating temperature range	-10 to +55°C (No icing)
Humidity	35 to 85% (No condensation)
Contact ratings	5A at 250V AC resistive load
Power consumption	Approx. 10VA at AC, Approx. 1W at DC,
Insulation resistance	100MΩ at 500 DC megger
Dielectric strength	2000V AC 1min. between current carrying part and non-current carrying part 2000V AC 1min. between output contact and control circuit 1000V AC 1min. between open contacts
Vibration	Malfunction durability: 10 to 55Hz, 0.5mm double amplitude Mechanical durability: 10 to 55Hz, 0.75mm double amplitude
Shock	Malfunction durability: 100m/s ² Mechanical durability: 500m/s ²
Durability	Mechanical: 20 million operations Electrical: 100000 operations at 240V AC 5A resistive load
Mass	Approx. 100g

■ Standards

UL file No.: E44592
TÜV License No.: R50007315 (MS4SM)
R50006667 (MS4SA, MS4SC)

Time Delay Relays

Super Timers

MS4S

■ Timing and wiring diagrams

MS4SM

1. On-delay **PO**

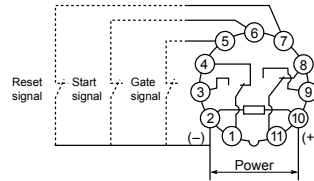
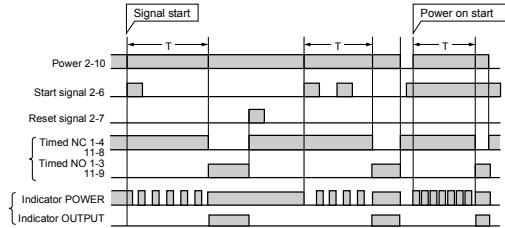

- Turn the mode selector until **PO** is displayed.
- When power is on, applying the start signal turns the timed NO (Normally open) contact on after the set time has elapsed.
- For the power-on start, the start signal pins (2 and 6) must be connected in advance.

2. Flicker **FL**

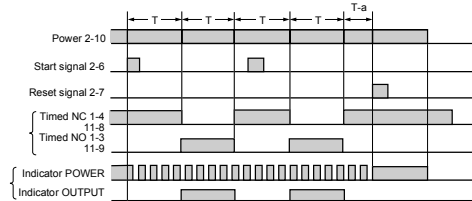

- Turn the mode selector until **FL** is displayed.
- When power is on, applying the start signal turns the timed contact on and off repeatedly at the set time intervals.

3. One-shot **OS**

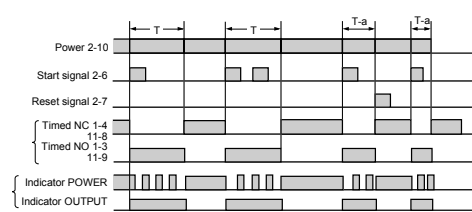

- Turn the mode selector until **OS** is displayed.
- When power is on, applying the start signal instantly turns the timed NO contact on and turns it off after the set time has elapsed.

4. Signal off-delay **SF**

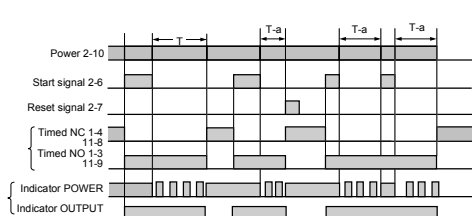

- Turn the mode selector until **SF** is displayed.
- When power is on, applying the start signal instantly turns the timed NO contact on. Removing the start signal turns the contact off after the set time has elapsed.

MS4SA

● On-delay

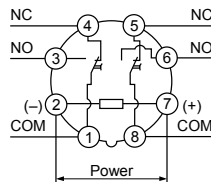
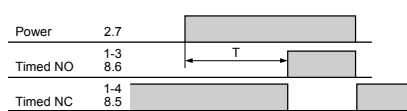

- When power is applied, the timed NO contacts make after the set time has elapsed.
- When power is removed, the contacts reset.

MS4SC

● On-delay

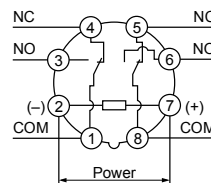
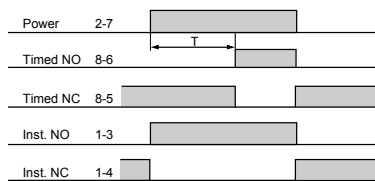

- Timed contact
When power is applied, the NO contact makes after the set time has elapsed. When power is removed, the contacts reset.
- Instantaneous contact
When power is applied, the NO contact makes instantly. When power is removed, the contacts reset.

Notes: • T=Set time, T-a=Time period within the set time
• The gate signal is used to interrupt the elapsing of timing operation.

■ Specifications (MS4SF, MS4SF-R, MS4SY)

Type	Ordering Code	Input voltage	Operation	Contact	Timing range
MS4SF	MS4SF-AP■ MS4SF-CE■ MS4SF-DL■	100-240V AC 24V AC/DC 48-127V DC	OFF-delay	Timed: 2PDT 5A	0.05-0.6 (s, min) 0.1-1.2 (s, min)
	MS4SF-AP■R MS4SF-CE■R MS4SF-DL■R	100-240V AC 24V AC/DC 48-127V DC		Timed: SPDT with inst. reset: SPDT	0.5-6 (s, min) 1-12 (s, min)
MS4SY	MS4SY-AP	100-240V AC	Star-delta	Timed 1 NO (star output) Timed 1 NO (delta output) + Instant 1NO	Star starting time 0.5-6s, 1-12s, 5-60s, 10-120s
					Star-delta chengeover time 0.05s, 0.1s, 0.25s, 0.5s

Note: Enter the timing range code in the ■ mark, see page 03/50.

03

■ Technical data

Type	MS4SF	MS4SF-R	MS4SY
Repeat accuracy	±0.3% at max. setting time		
Reset time	-		0.5s or less
Operating voltage range	0.85 to 1.1 times rated input voltage		
Operating temperature range	-10 to +55°C(No icing)		
Humidity	35 to 85% RH (No condensation)		
Contact ratings	3A at 250V AC resistive load	5A at 250V AC resistive load	
Power consumption	Approx. 1VA at AC, Approx. 1W at DC		
Insulation resistance	100MΩ at 500V DC megger		
Dielectric strength	2000V AC 1min. between current carrying part and non-current carrying part 2000V AC 1min. between output contact and control circuit 1000V AC 1min. between open contacts		
Vibration	Malfunction durability: 10 to 55Hz, 0.5mm double amplitude		
Shock	Mechanical durability: 10 to 55Hz, 0.75mm double amplitude Malfunction durability: 100m/s ² Mechanical durability: 500m/s ²		
Durability	Mechanical	10 million operations	20 million operations
	Electrical	100000 operations at 250V AC 3A res. load	80000 operations at 250V AC 5A res. load
Mass	Approx. 100g		

■ Standards

UL file No. : E44592

Time Delay Relays

Super Timers

MS4S

■ Timing and wiring diagrams

● MS4SF type off-delay timer

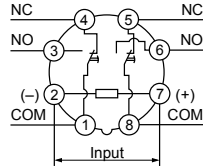

MS4SF-R type off-delay timer

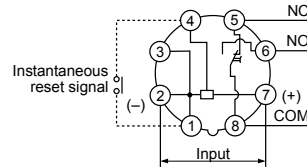

MS4SY type star-delta timer

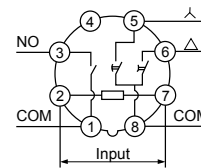

Note: Do not use terminal ③ of the MS4SF-R as a relay terminal because it is connected to terminals ① and ② in the timer.

● MS4SF type

Operation	Operation pattern	Remarks
Off-delay (Timed 2PDT contacts)		<ul style="list-style-type: none"> When power is on, timed NO contact on. When power is off, timed NO contact off after the set time has elapsed.

● MS4SF-R type

Operation	Operation pattern	Remarks
Off-delay (Timed SPDT contact)		<ul style="list-style-type: none"> When power is on, timed NO contact on. When power is off, timed NO contact off after the set time has elapsed. When the instantaneous reset signal is on, timed NO contact immediately off.

Notes: • T-a indicates some time within a set time.
 • Each signal can be input by shorting the terminals.
 • For the MS4SF-R, apply the instantaneous reset signal for 100 ms or longer.

● MS4SY type

Operation	Operation pattern	Remarks
λ - Δ (with instantaneous contact 1NO)		<ul style="list-style-type: none"> Timed contact Timed contact λ on when the power is on, and off after a set time. Timed contact Δ on after a changeover time has elapsed and opens when the power turns off. Instantaneous contact When the power is turned on, instantaneous NO contact on. It opens when the power turns off.

■ Specifications (MS4SR)

Type	Ordering code	Input voltage	Operation mode		Contact	Timing range
MS4SR	MS4SR-AP	100-240V AC	Off-start	On-off repetitive operation	Timed: 2PDT 5A	0.5-6 (×0.1s, s, min, h)
	MS4SR-CE	24V AC/DC				1-12 (×0.1s, s, min, h)
	MS4SR-DL	48-127V DC				2.5-30 (×0.1s, s, min, h)
	MS4SR-APN	100-240V AC	On-start			5-60 (×0.1s, s, min, h)
	MS4SR-CEN	24V AC/DC				
	MS4SR-DLN	48-127V DC				

■ Technical data (MS4SR)

Repeat accuracy	±0.3%±0.01s at max. setting time
Reset time	0.1s or less
Operating voltage range	0.85 to 1.1 times rated input voltage
Operating temperature range	-10 to +55°C(No icing)
Humidity	35 to 85% RH (No condensation)
Contact ratings	5A at 250V AC resistive load
Power consumption	Approx. 10VA at AC, Approx. 1W at DC
Insulation resistance	100MΩ at 500V DC megger
Dielectric strength	2000V AC 1min. between current carrying part and non-current carrying part 2000V AC 1min. between output contact and control circuit 1000V AC 1min. between open contacts
Vibration	Malfunction durability: 10 to 55Hz, 0.5mm double amplitude Mechanical durability: 10 to 55Hz, 0.75 mm double amplitude
Shock	Malfunction durability: 100m/s ² Mechanical durability: 500m/s ²
Durability	Mechanical: 20 million operations Electrical: 100000 operations at 250V AC 5A resistive load
Mass	Approx. 100g

■ Wiring diagram

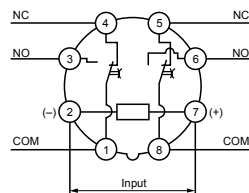

■ Operation pattern

MS4SR

Operation	Operation pattern	Remarks
Repeat (Off-start)		<ul style="list-style-type: none"> When power is on, timed contacts on and off every set time interval. The contacts reset when the power is removed.

MS4SR-N

Operation	Operation pattern	Remarks
Repeat (On-start)		<ul style="list-style-type: none"> When power is on, timed contacts on and off every set time interval. The contacts reset when the power is removed.

Time Delay Relays

Super Timers

MS4S

■ Dimensions, mm

● Bodies

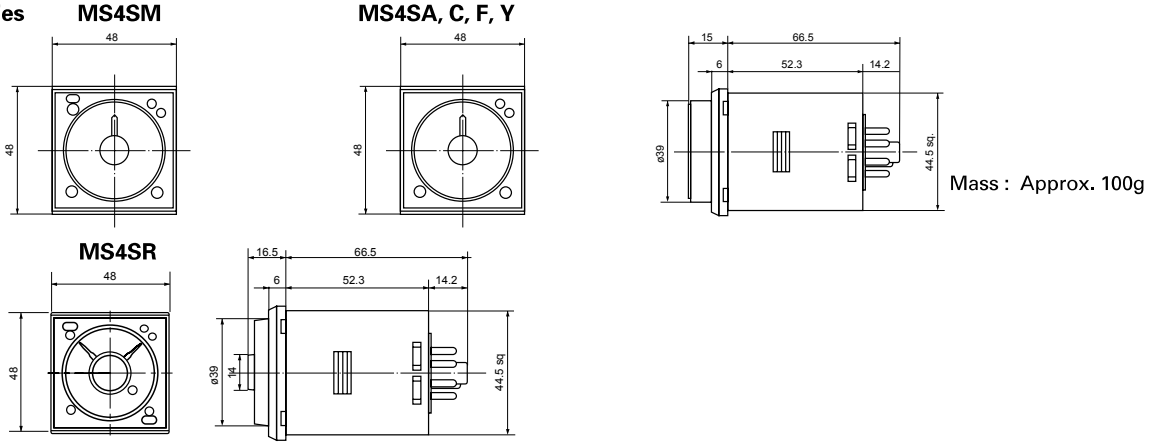

● Sockets for surface mounting

TP411X (11-pin) for MS4SM

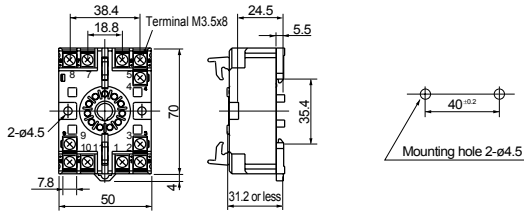

Mass : Approx. 70g

TP48X (8-pin) for MS4S□

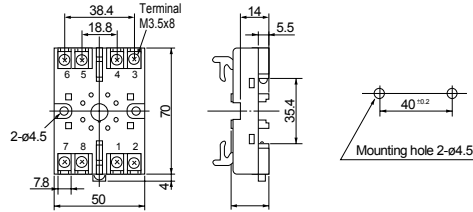

Mass : Approx. 59g

8GB, 11GB (Soldering sockets)

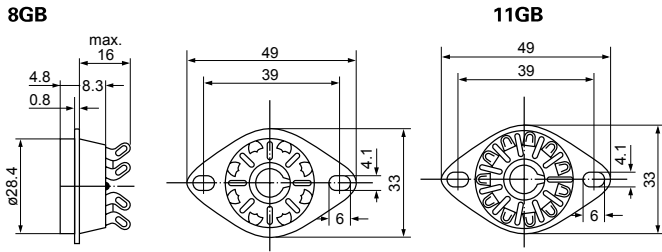

Mass : Approx. 13g

Approx. 13g

Note: Where ordering the 8GB and 11GB types of surface mounting socket, specify hold-down spring FX3 separately.

Where mounted from back side of mounting plate

Panel cutting

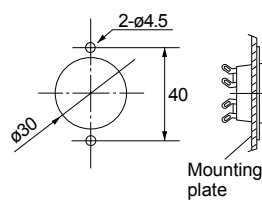

Hold-down spring/FX3

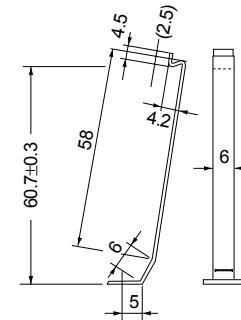

Mounting rails

TH35-7.5
Steel

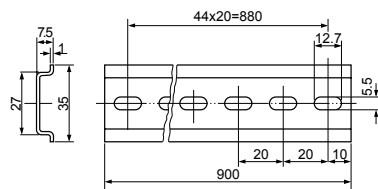

Mass : 290g

TH35-7.5AL
Aluminum

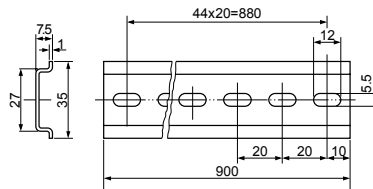

Mass : 145g

TH35-15AL
Aluminum

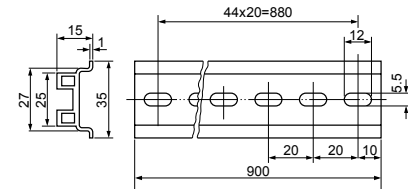

Mass : 320g

■ Dimensions, mm

● Sockets for flush mounting

TX4

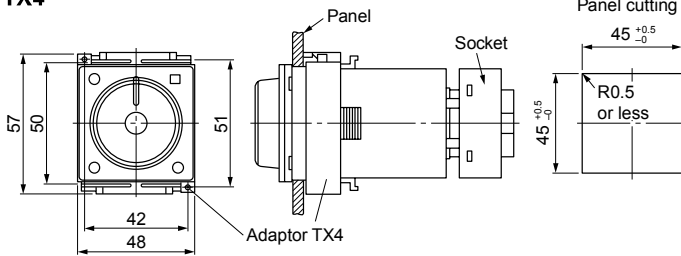

Mass : Approx. 15g

For flush mounting, an adaptor TX4 (sold separately) is required to fix the timer to the panel.
The illustration shows a timer being fixed to a panel, using the adaptor TX4.

● Accessories (supplied)

TX4 adaptor

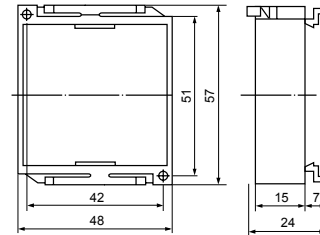

03

TP411SBA (11-pin) for MS4SM

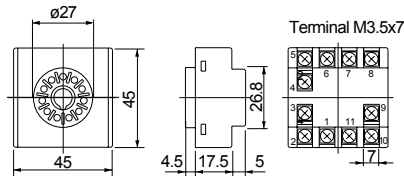

Mass : Approx. 43g

TP48SB (8-pin) for MS4SA, MS4SC

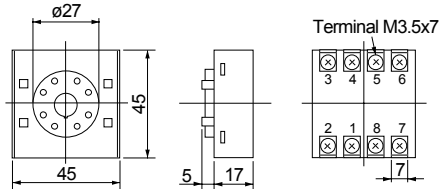

Mass : Approx. 38g

ATX2NS (Soldering socket)

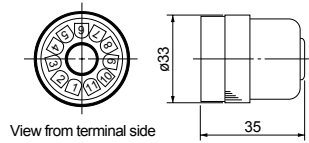

Mass : Approx. 20g

ATX1NS (Soldering socket)

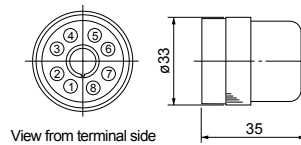

Mass : Approx. 18g

■ Notes on use

Refer to the instruction manual.

Time Delay Relays

Super Timers

ST7P, 7B

Miniature size Super Timer ST7P series

The ST7P and ST7B series are compact and highly accurate Super Timers.

The ST7P and ST7B are on-delay operation types.

■ Features

- These Super Timers are highly accurate. Their repeat accuracy is less than $\pm 1\%$ at maximum setting time.

- Timing range
ST7P and ST7B are the single timing range types; 0.06 sec. to 24 hours.
- The large setting dial makes time setting easy.
- The LED indicators make it easy to check timer operation.
- The ST7P has been approved by the UL, cULus and TÜV.

■ Standards

UL file No. Body: E44592
Socket: E90265
TÜV License No.: R50004818



■ Specifications

Single timing range types

Type	Ordering code	Contact	Operation	Timing range (Refer to Page 03/50)	Input voltage	Socket
ST7P-2	MS7P2-■□	Timed: 2PDT	On-delay	0.06–0.5s 4–60s 0.5–6h 0.1–1s 0.25–3min 1–12h 0.3–3s 1–10min 2–24h	200-230V AC 50/60Hz 100-120V AC 50/60Hz 240V AC 50/60Hz	Screw Soldering Wire wrap PC board
ST7P-4	MS7P4-■□	Timed: 4PDT		0.4–5s 2–30min 1–10s 4–60min	100-110V DC 24V DC	
ST7B-2	MS7B2-■□	Timed: 2PDT		2–30s 0.2–2h	12V DC	
ST7B-4	MS7B4-■□	Timed: 4PDT				

Notes: Enter the input voltage code in the ■ mark and timing range code in the □ mark. * Other voltages are available on request, contact FUJI.

■ Technical data

Repeat accuracy	$\pm 1\%$ at max. setting time
Reset time	0.1s or less
Max. operating cycle	1800 cycles/h
Operating temperature range	-10°C to 50°C
Mechanical durability	50 million operations
Electrical durability	500000 operations at 220V AC 3A resistive load (ST7P-2, 7B-2) 100000 operations at 220V AC 3A resistive load (ST7P-4, 7B-4)
Operating voltage range	0.85 to 1.1 times input voltage
Contact ratings	3A at 220V AC resistive load
Power consumption	1.2VA at 100V AC, 1.5VA at 200V AC, 1.1W at 24V DC
Dielectric strength	2000V AC rms. 1min. between current carrying part and non current carrying part 1500V AC rms. 1min. between output contacts and control circuit 1000V AC rms. 1min. between open contacts
Insulation resistance	100M Ω at 500V DC megger
Vibration	Mechanical durability: 10 to 55Hz, 0.75mm double amplitude Malfunction durability: 10 to 55Hz, 0.5mm double amplitude
Shock	Mechanical durability: 1000m/s ² Malfunction durability: 50m/s ²

■ Timing diagrams ST7P-2, 7B-2

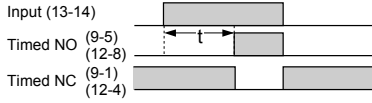

ST7P-4, 7B-4

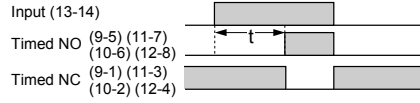

■ Wiring diagrams ST7P-2, 7B-2

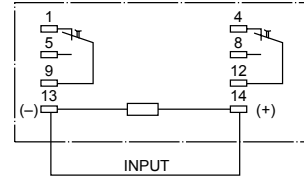

■ Dimensions, mm ● Bodies

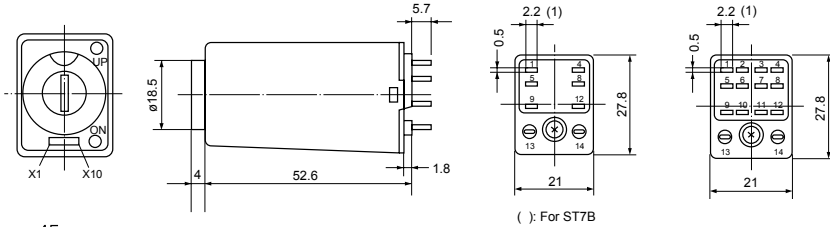

Mass: 45g

● Sockets/Screw terminal and rail mounting TP88X1 (M3)

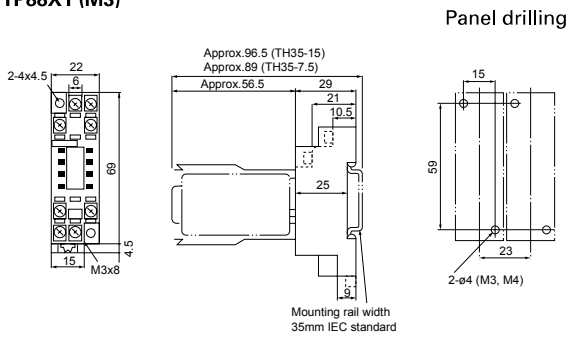

TP814X1 (M3)

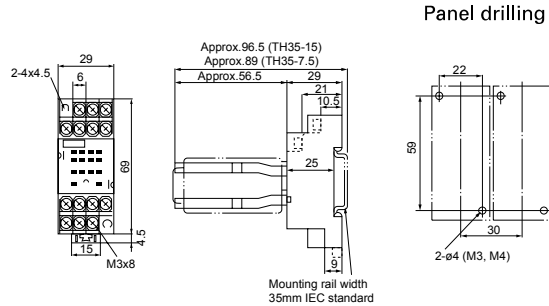

TP88X2 (M3.5)

TP814X2 (M3.5)

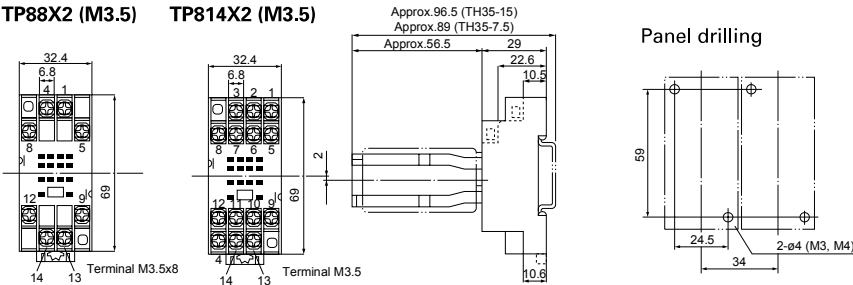

■ Socket's terminal arrangement

TP88X1, TP88X2

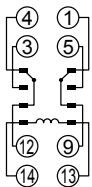

TP814X1, TP814X2

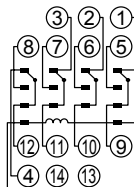

Time Delay Relays

Super Timers

ST7P, 7B

■ Dimensions, mm

● Sockets/soldering

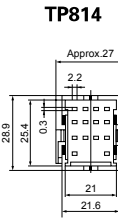
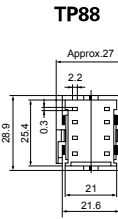
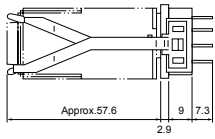

Terminal



Panel cutting

TP88, 814

TP88R2, 814R2

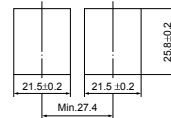

● Sockets/Wire wrap

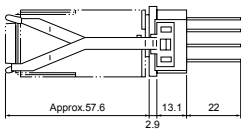

TP88R2

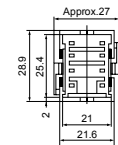

TP814R2

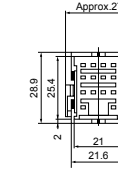

Terminal



● Sockets/PC board

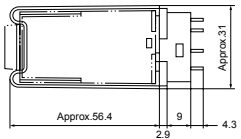

TP88B

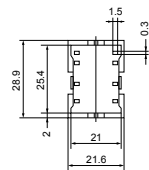

TP814B

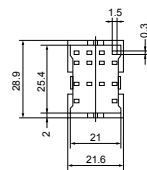

PC board drilling

TP88B

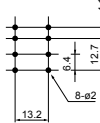

TP814B

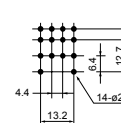

Sockets

Terminal	For ST7P-2, ST7B-2			For ST7P-4, ST7B-4			Finger protection cover	
	Type	Ordering code	Mass (g)	Type	Ordering code	Mass (g)	Type	Ordering code
Screw terminal, rail mounting	TP88X1(M3)	MX58X1	35	TR814X1(M3)	MX54X1	54	RZ52X1	RZ52X1
Screw terminal, rail mounting	TP88X2(M3.5)	MX58X2	47	TP814X2(M3.5)	MX54X2	51	RZ54X1	RZ54X1
Soldering	TP88	MX58	9	TP814	MX54	10	FX14X2	RZ54X2
Wire wrap	TP88R2	MX58R2	11	TP814R2	MX54R2	13		
PC board	TP88B	MX58B1	9	TP814B	MX54B	10		

● Mounting rails: See page 03/58.

■ Type number nomenclature

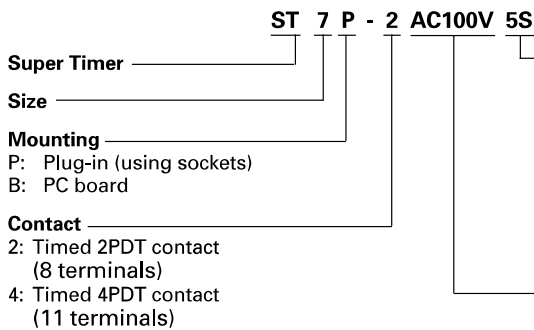

Timing range

● ST7P-□, 7B□

0.5S: 0.06–0.5s	3M: 0.25–3min
1S: 0.1–1s	10M: 1–10min
3S: 0.3–3s	30M: 2–30min
5S: 0.4–5s	60M: 4–60min
10S: 1–10s	2H: 0.2–2h
30S: 2–30s	6H: 0.5–6h
60S: 4–60s	12H: 1–12h

Input voltage

● ST7P, 7B

AC200V: 200–230V AC
AC100V: 100–120V AC
AC240V: 240V AC
DC100V: 100–110V DC
DC24V: 24V DC
DC12V: 12V DC

■ Ordering information

Specify the following:

- Ordering code or type number of body (add a suffix of the timing range) and socket. (Socket is sold separately.)